

INSTRUCTION SHEET

758-657T/B

Affinity Dining Table

Thank you for purchasing this quality product. Be sure to check all packing material carefully for small parts that may have come loose inside the carton during shipment.

Caution: (1) These parts are cumbersome and heavy. This product can best be assembled with the assistance of one or more persons in order to prevent personal injury and to insure parts are not damaged during the assembly process. If dirty, clean finished parts with mild dishwashing liquid and water solution applied on damp cloth. Cloth should not be excessively wet. Polish finish with soft cloth and an industry recognized furniture polish.

(2) To prevent damage to your floor or carpet, please check the bottom of each piece of furniture for stain residue and rough surfaces and also check for staples or nails left after removing the packaging material. The manufacturer will not be held responsible if preventative steps are not taken prior to installation.

(3) Unpack and dispose of all packing material but be careful not to throw away any assembly parts or hardware. Read the instruction sheet and parts list carefully. Remove all staples and screws used for packaging carefully using pliers and or screwdrivers to prevent injury and scratching or damaging flooring.

(4) During normal use everyday, screws, bolts, nuts and wooden plugs may loosen up. They should be periodically inspected and re-tightened to prevent damage to the furniture and (or) personal property or cause injury. Always check to be sure all hardware on this list and the above mentioned components is attached to the furniture properly and kept tightened at all times.

PARTS LIST:

#	Description	Qty.	#	Description	Qty.
A	Table Top	1pc	B	Mounting Plate	1pc
C	Pedestal	1pc	D	Base	1pc
E	Hardware Pack	1bag			

Assembly Procedure: (Please follow the sketches below.)

Step 1: Unpack, inspect, and read assembly instruction carefully. Lay out the parts and hardware. Make sure the quantity of each is correct.

Step 2: Detach mounting plate (B) off table top (A) using wrench (1), keep the bolts, spring washers and flat washers for step 4.

Step 3: Attach base (D) to pedestal (C) with phillip head bolts (2), spring washers (3) and flat washers (4) using wrench (1). Turn it over, attach the other side of pedestal (C) to mounting plate (B) with nuts (5), spring washers (3), and flat washers (4) using wrench (1) from hardware pack (E).

Step 4: Attach mounting plate (B) to table top (A) with the bolts, spring washers and flat washers from step 2. Turn the table upright.





Note: It is best two persons are involved.

Assembly is now complete.

INSTRUCTION SHEET

758-657T/B

Affinity Dining Table

HARDWARE LIST(E)			Q'TY
1	WRENCH	 12mm	1PC
2	PHILLIP HEAD BOLT	 5/16"*2-1/2"	4PCS
3	SPRING WASHER	 5/16"*13*2mm	8PCS
4	FLAT WASHER	 5/16"*23*2mm	8PCS
5	NUT	 5/16"	4PCS

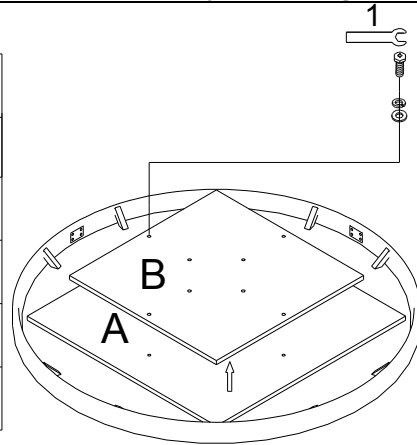

Step 2

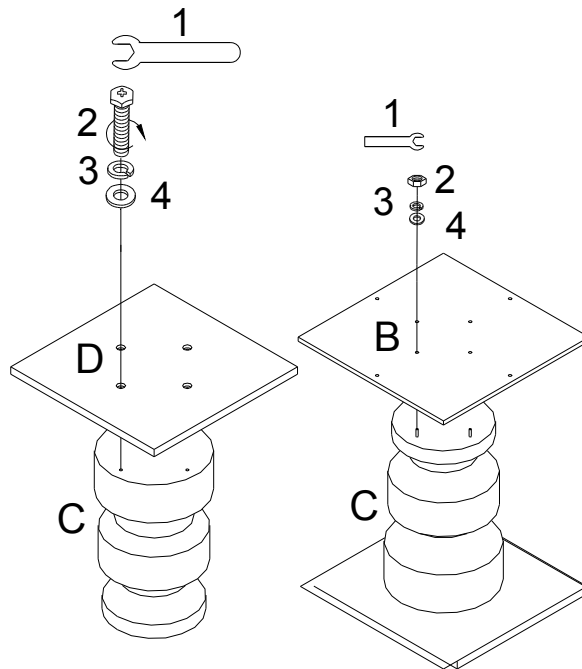

Step 3

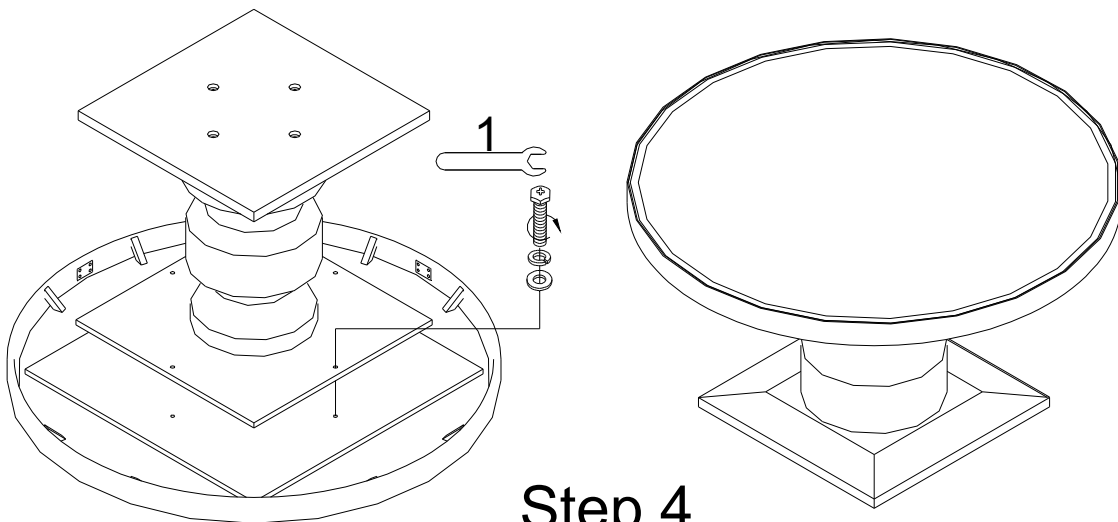

Step 4