

INSTRUCTION SHEET

311/316/318-755

Flat Iron Table

Thank you for purchasing this quality product. Be sure to check all packing material carefully for small parts that may have come loose inside the carton during shipment.

Caution: (1) These parts are cumbersome and heavy. This product can best be assembled with the assistance of one or more persons in order to prevent personal injury and to insure parts are not damaged during the assembly process. If dirty, clean finished parts with mild dishwashing liquid and water solution applied on damp cloth. Cloth should not be excessively wet. Polish finish with soft cloth and an industry recognized furniture polish.

(2) To prevent damage to your floor or carpet, please check the bottom of each piece of furniture for stain residue and rough surfaces and also check for staples or nails left after removing the packaging material. The manufacturer will not be held responsible if preventative steps are not taken prior to installation.

(3) Unpack and dispose of all packing material but be careful not to throw away any assembly parts or hardware. Read the instruction sheet and parts list carefully. Remove all staples and screws used for packaging carefully using pliers and or screwdrivers to prevent injury and scratching or damaging flooring.

(4) During normal use everyday, screws, bolts, nuts and wooden plugs may loosen up. They should be periodically inspected and re-tightened to prevent damage to the furniture and (or) personal property or cause injury. Always check to be sure all hardware on this list and the above mentioned components is attached to the furniture properly and kept tightened at all times.

PARTS LIST:

#	Description	Qty.	#	Description	Qty.
A	Table Top	1pc	B	Mounting Plate	2pcs
C	Connecting Rail	1pc	D	Side Post	2pcs
E	Decorative Pad	2pcs	F	Hardware pack	1bag

Assembly Procedure: (Please follow the sketches below.)

Step 1: Unpack, inspect, and read assembly instruction carefully. Lay out the parts and hardware. Make sure the quantity of each is correct.

Step 2: Detach the mounting plate (B) from bottom of table top (A) with wrench (7). Keep the bolts, spring washers and flat washers for step 4.

Step 3: Insert wood dowels (9) into the predrilled holes in the side posts (D), and then attach connecting rail (C) to side posts (D) from outside of side posts (D) with allen head bolts (4), spring washers (5) and flat washers (6) using allen wrench (8). Fill the holes on the outside of side posts (D) with decorative pad (E) on both side. Then attach mounting plates (B) to top of side posts (D) with nuts (1), spring washers (2) and flat washers (3) using wrench (4).

Step 4: Turn the base over, and attach the mounting plate (B) to the table top (A) with the bolts, lock washers and flat washers from step 2.

Step 6: Turn the table upright.

Note: If handled improperly, the act of installing and removing table leaf may damage the table. Please use caution and delicate handling when installing and removing table leaf to prevent damaging the table top surface and edges. It is best two persons are involved when installing or removing table leaf.

Assembly is now complete.







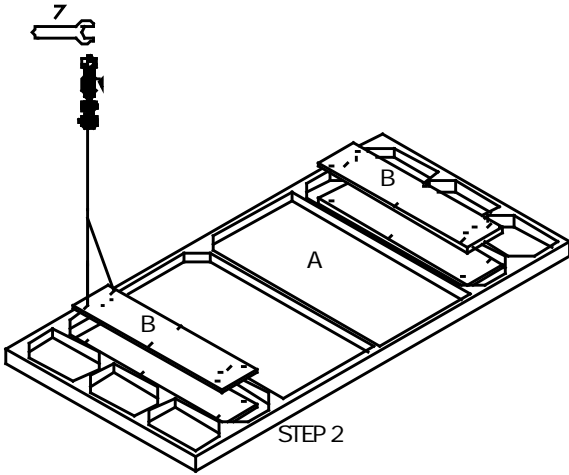

INSTRUCTION SHEET

311/316/318-755

Flat Iron Table



HARDWARE PACK (F)

1	NUT		10PCS
2	SPRING WASHER		10PCS
3	FLAT WASHER		10PCS
4	ALLEN HEAD BOLT		4PCS
5	SPRING WASHER		4PCS
6	FLAT WASHER		4PCS
7	WRENCH		1PC
8	ALLEN WRENCH		1PC
9	WOOD DOWEL		8PCS

