

## INSTRUCTION SHEET

805260/26FR  
805250/25FR

MIDTOWN BED

Thank you for purchasing this quality product. Be sure to check all packing material carefully for small parts that may have come loose inside the carton during shipment.

**Caution:** (1) These parts are cumbersome and heavy. This product can best be assembled with the assistance of one or more persons in order to prevent personal injury and to insure parts are not damaged during the assembly process. If dirty, clean finished parts with mild dishwashing liquid and water solution applied on damp cloth. Cloth should not be excessively wet. Polish finish with soft cloth and an industry recognized furniture polish.

(2) To prevent damage to your floor or carpet, please check the bottom of each piece of furniture for stain residue and rough surfaces and also check for staples or nails left after removing the packaging material. The manufacturer will not be held responsible if preventative steps are not taken prior to installation.

(3) Unpack and dispose of all packing material but be careful not to throw away any assembly parts or hardware. Read the instruction sheet and parts list carefully. Remove all staples and screws used for packaging carefully using pliers and or screwdrivers to prevent injury and scratching or damaging flooring.

(4) During normal use everyday, screws, bolts, nuts and wooden plugs may loosen up. They should be periodically inspected and re-tightened to prevent damage to the furniture and (or) personal property or cause injury. Always check to be sure all hardware on this list and the above mentioned components is attached to the furniture properly and kept tightened at all times.

### PARTS LIST:

#	Description	Qty.	#	Description	Qty.
A	Headboard	1 pc	B	Wings	2 pcs
C	Side Rail	2pcs	D	Footboard	1pcs
E	Slat Panel	3pcs	F	Center support	6pcs
G	Headboard legs	2pcs	H	Footboard legs	2pcs

### Assembly Procedure: (Please follow the sketches below.)

**Step 1:** Unpack, inspect, and read assembly instruction carefully. Lay out the parts and hardware. Make sure the quantity of each is correct.

**Step 2:** Unzipping from the back of headboard ,install wings(B) to the headboard(A) with bolt (7),spring washer (8)and flat washer (9).Tighten them by wrench (10).

**Step 3:**Attach the headboard legs(G) with the bolt (11) and spring washer (8) to the holes on the bottom of headboard(A) . Screw footboard legs(H) into holes on the bottom of footboard (D)..





**Step 4:**Assemble side rails(C) with headboard(A) and footboard(D) using bolts (1), curved washers(2) , spring washers(3) and nuts(4). Tighten them by wrench (6).

**Step 5:** Screw center supports (6) into slat panels (E).Put slat panels(E) onto the inside notches of side rails(C) , tighten them with screws(5) by screwdriver (not provided).



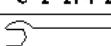

**Note:** 805250/25FR bed has 3pcs center support.

### Assembly is now complete.

#### Footboard/Side rails

1	BOLT	 5/16"*3"	8PCS
2	CURVED WASHER	 27.5*8*15mm	8PCS
3	SPRING WASHER	 5/16"	8PCS
4	NUT	 13*13*5mm	8PCS
5	SCREW	 8*1-1/4"mm	6PCS
6	WRENCH	 87*19mm	1PC

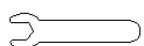
#### Headboard

7	BOLT	 5/16"*2-1/2"	10PCS
8	SPRING WASHER	 5/16"	14PCS
9	Flat Washer	 1/4"*16*1.5mm	10PCS
10	WRENCH	 87*19mm	1PC
11	BOLT	 5/16"*3"	4PCS

## INSTRUCTION SHEET

805260/26FR  
805250/25FR

MIDTOWN BED

### Step 2

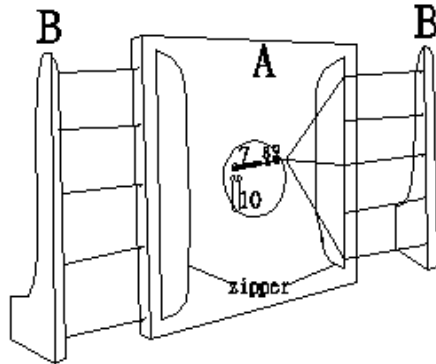

### Step 3

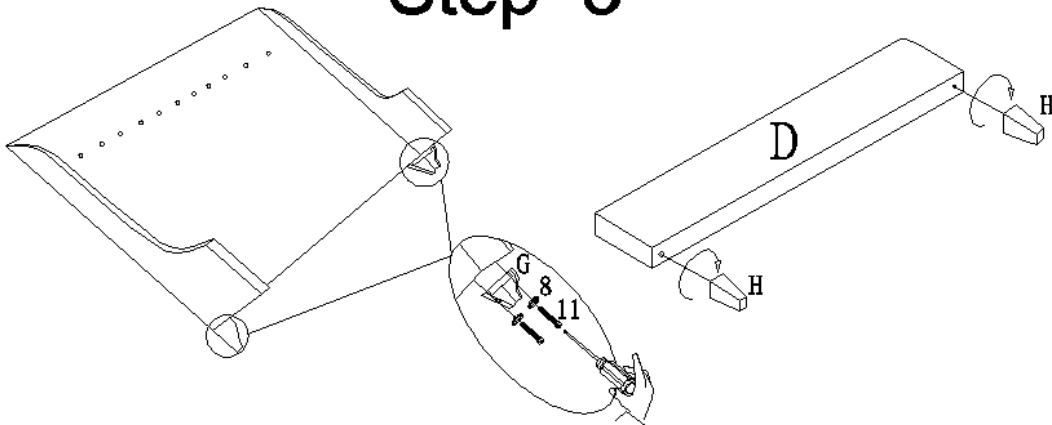

### Step 4

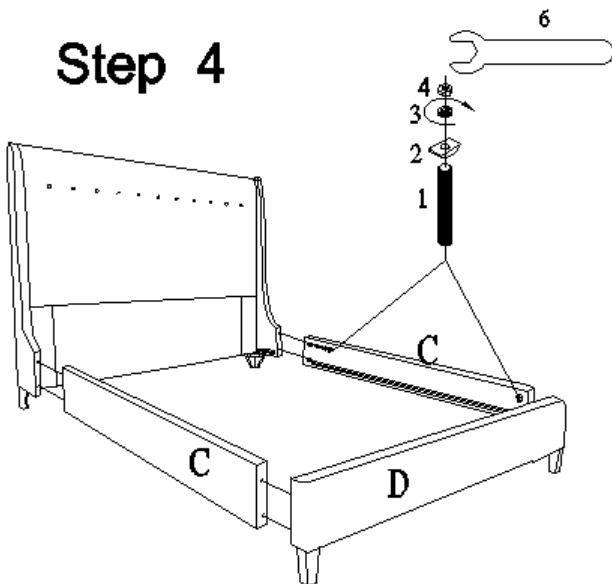

### Step 5

