

INSTRUCTION SHEET

ASSEMBLY INSTRUCTIONS U011A255H/ U011A255F/ U011A255R/ U011SLQN Panel Bed Queen 50

Thank you for purchasing this quality product. Be sure check all packing material carefully for small parts that may have come loose inside the carton during shipping.

Caution: (1) These parts are cumbersome and heavy. This product can best be assembled with the assistance of one or more persons in order to prevent personal injury and to insure parts are not damaged during the assembly process. If dirty, clean finished parts with mild dishwashing liquid and water solution applied on damp cloth. Cloth should not be excessively wet. Polish finish with soft cloth and an industry recognized furniture polish.

(2) To prevent damage to your floor or carpet, please check the bottom of each piece of furniture for stain residue and rough surfaces and also check for staples or nails left after removing the packaging material. The manufacturer will not be held responsible if preventative steps are not taken prior to installation.





(3) Unpack and dispose of all packing material but be careful not to throw away any assembly parts or hardware. Read the instruction sheet and parts list carefully. Remove all staples and screws used for packaging carefully using pliers and or screwdrivers to prevent injury and scratching or damaging flooring.

(4) During normal use everyday, screws, bolts, nuts and wooden plugs may loosen up. They should be periodically inspected and re-tightened to prevent damage to the furniture and (or) personal property or cause injury. Always check to be sure all hardware on this list and the above mentioned components is attached to the furniture properly and kept tightened at all times.







OPTION 1: MATTRESS WITH FOUNDATION

Assembly Procedure: (Please follow the sketches below.)

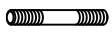
Parts List:

Description		QTY	Description		QTY
Headboard (A)		1 pc	Side Rail (C)		2 pcs
			Support Leg (D)		5 pcs
Footboard (B)		1 pc	Slat (E)		5 pcs

Hardware List:

1	Threaded bolt	5/16"x3"		8 pcs	4	Nut	5/16"		8 pcs
2	Curve washer	5/16"		8 pcs	5	Wrench	12mm		1 pc
3	Spring washer	5/16"		8 pcs	6	Screw	#8x1-1/4"		10 pcs

Step 1: Unpack, inspect, and read assembly instruction carefully. Lay out the parts and hardware. Make sure the quantity of each is correct.

Step 2: Assemble siderail (C) to headboard (A) and footboard (B) using Threaded bolt (1), curve washer (2), spring washer (3), nut (4). Tighten all nuts securely with Wrench (5), but do not over tighten.

Step 3: Assemble each support leg (D) into each slat (E).

Step 4: Attach each slat (E) on the side rails (C) using screws (6) as shown. Adjust the height of each support leg (D) by turning adjustable levelers located on the bottom of each support leg (D), clockwise to lower and counterclockwise to raise.

Assembly is now complete.

INSTRUCTION SHEET

ASSEMBLY INSTRUCTIONS

U011A255H/ U011A255F/ U011A255R/ U011SLQN Panel Bed Queen 50

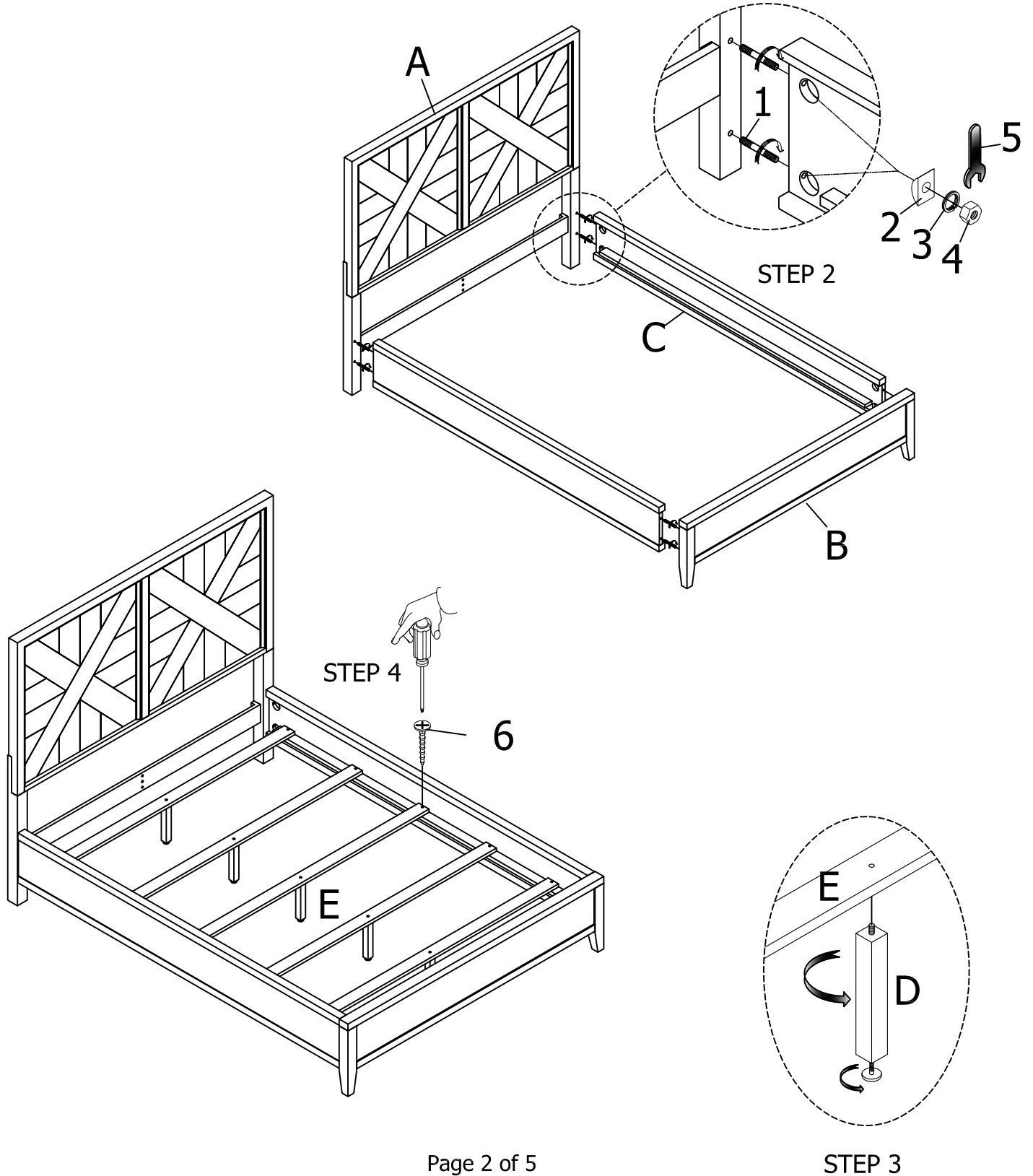







INSTRUCTION SHEET

ASSEMBLY INSTRUCTIONS







U011A255H/ U011A255F/ U011A255R/ U011SLQN Panel Bed Queen 50

OPTION 2: MATTRESS ONLY - NOTE: CENTER RAIL SLAT ROLL AND HARDWARE SOLD SEPERATELY

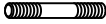
Parts List:

Description		QTY	Description		QTY
Headboard (A)		1 pc	Center Rail (F)		1 pc
Footboard (B)		1 pc	Center rail support (G)		1 pc
Side Rail (C)		2 pcs	Slat roll (H)		1 set

Hardware List:

1	Threaded bolt	5/16"x3"		10 pcs	5	Wrench	12mm		1 pc
2	Curve washer	5/16"		10 pcs	6	Screw	#8x1-1/4"		15 pcs
3	Spring washer	5/16"		10 pcs	7	Wood dowel	φ10x40mm		4 pcs
4	Nut	5/16"		10 pcs					

Assembly Procedure: (Please follow the sketches below.)

- Step 1:** Unpack, inspect, and read assembly instruction carefully. Lay out the parts and hardware. Make sure the quantity of each is correct.
- Step 2:** Assemble Center rail support (G) into Center rail (F).
- Step 3:** Assemble siderail (C) to headboard (A) using Threaded bolt (1), curve washer (2), spring washer (3), nut (4). Tighten all nuts securely with Wrench (5), but do not over tighten.
Insert the dowel (7) into the Headboard (A) as shown. Assemble Center rail (G) to headboard (A) using Threaded bolt (1), curve washer (2), spring washer (3), nut (4). Tighten all nuts securely with Wrench (5), but do not over tighten.
- Step 4:** Insert the dowel (7) into the Footboard (B) as shown. Assemble the footboard (B) to the Center rail (G) and the side rail (C) using Threaded bolt (1), curve washer (2), spring washer (3), nut (4). Tighten all nuts securely with Wrench (5), but do not over tighten.
- Step 5:** Attach the slat roll (H) on the side rails (C) using screws (6) as shown. Adjust the height of center rail support (G) by turning adjustable levelers located on the bottom of center rail support (G), clockwise to lower and counterclockwise to raise.

Assembly is now complete.

INSTRUCTION SHEET

ASSEMBLY INSTRUCTIONS

U011A255H/ U011A255F/ U011A255R/ U011SLQN Panel Bed Queen 50

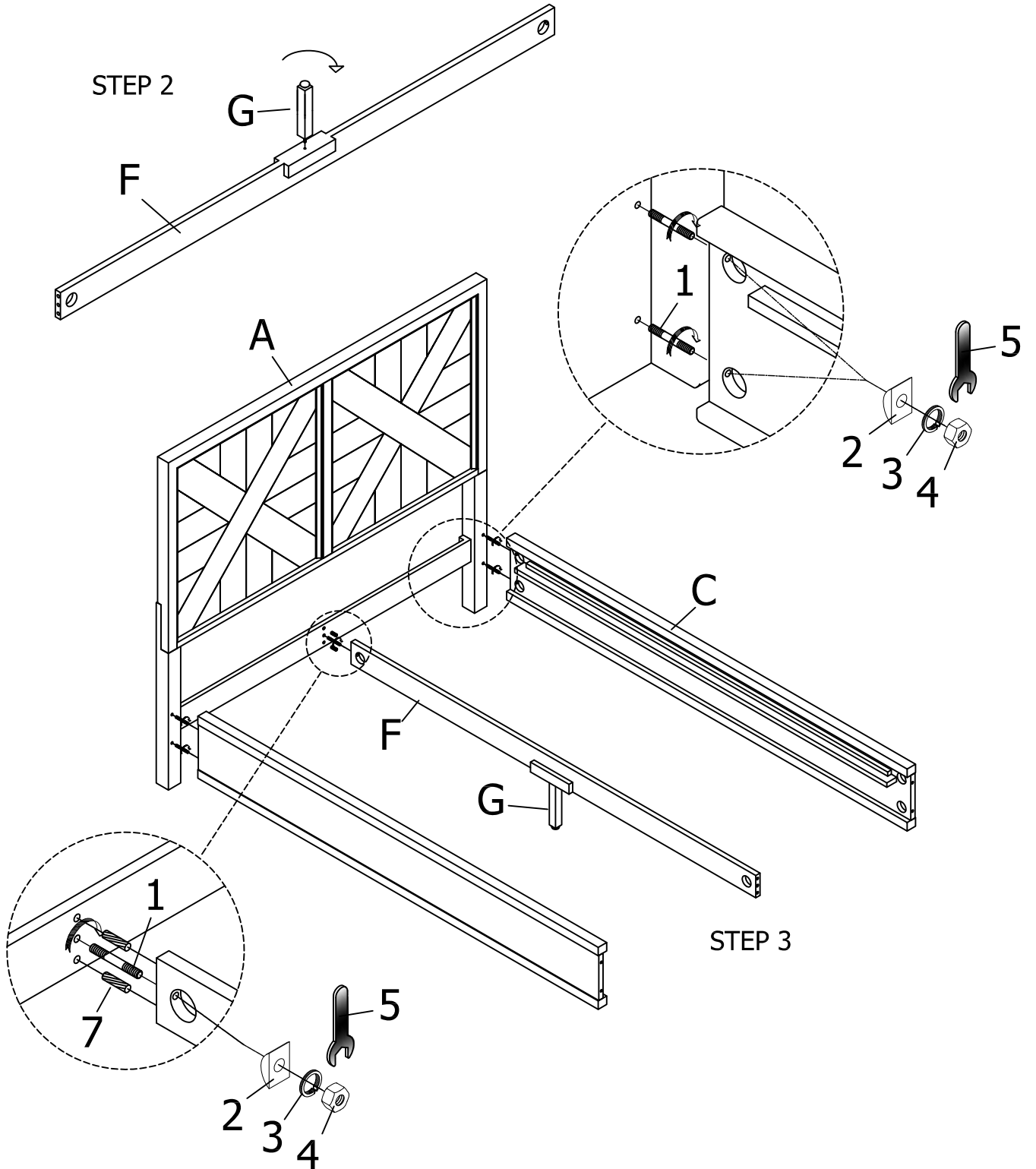

INSTRUCTION SHEET

ASSEMBLY INSTRUCTIONS

U011A255H/ U011A255F/ U011A255R/ U011SLQN Panel Bed Queen 50

