

INSTRUCTION SHEET

ASSEMBLY INSTRUCTIONS

U011220/ U01122FR/ U011SLKG UPH Bed King 66

Thank you for purchasing this quality product. Be sure check all packing material carefully for small parts that may have come loose inside the carton during shipping.





Caution: (1) These parts are cumbersome and heavy. This product can best be assembled with the assistance of one or more persons in order to prevent personal injury and to insure parts are not damaged during the assembly process. If dirty, clean finished parts with mild dishwashing liquid and water solution applied on damp cloth. Cloth should not be excessively wet. Polish finish with soft cloth and an industry recognized furniture polish.

(2) To prevent damage to your floor or carpet, please check the bottom of each piece of furniture for stain residue and rough surfaces and also check for staples or nails left after removing the packaging material. The manufacturer will not be held responsible if preventative steps are not taken prior to installation.



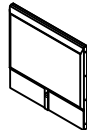

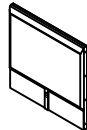
(3) Unpack and dispose of all packing material but be careful not to throw away any assembly parts or hardware. Read the instruction sheet and parts list carefully. Remove all staples and screws used for packaging carefully using pliers and or screwdrivers to prevent injury and scratching or damaging flooring.

(4) During normal use everyday, screws, bolts, nuts and wooden plugs may loosen up. They should be periodically inspected and re-tightened to prevent damage to the furniture and (or) personal property or cause injury. Always check to be sure all hardware on this list and the above mentioned components is attached to the furniture properly and kept tightened at all times.

Parts List:

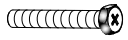
Description		QTY	Description		QTY
Headboard Middle panel (A)		1 pc	Headboard Right panel (C)		1 pc
Headboard Left panel (B)		1 pc			

Headboard Hardware List:

8	Hex head bolt	5/16"x2-1/2"		12 pcs	10	Flat washer	5/16"x19mm		12 pcs
9	Spring washer	5/16"		12 pcs	5	Wrench	12mm		1 pc

Assembly Procedure: (Please follow the sketches below.)

Step 1: Unpack, inspect, and read assembly instruction carefully. Lay out the parts and hardware. Make sure the quantity of each is correct.

Step 2: Assemble HB left panel (B) and HB right panel (C) to HB middle panel (A) using Hex Head bolt (8), spring washer (9), flat washer (10). Tighten all bolts securely with Wrench (5), but do not over tighten the bolts.

INSTRUCTION SHEET

ASSEMBLY INSTRUCTIONS

U011220/ U01122FR/ U011SLKG UPH Bed King 66

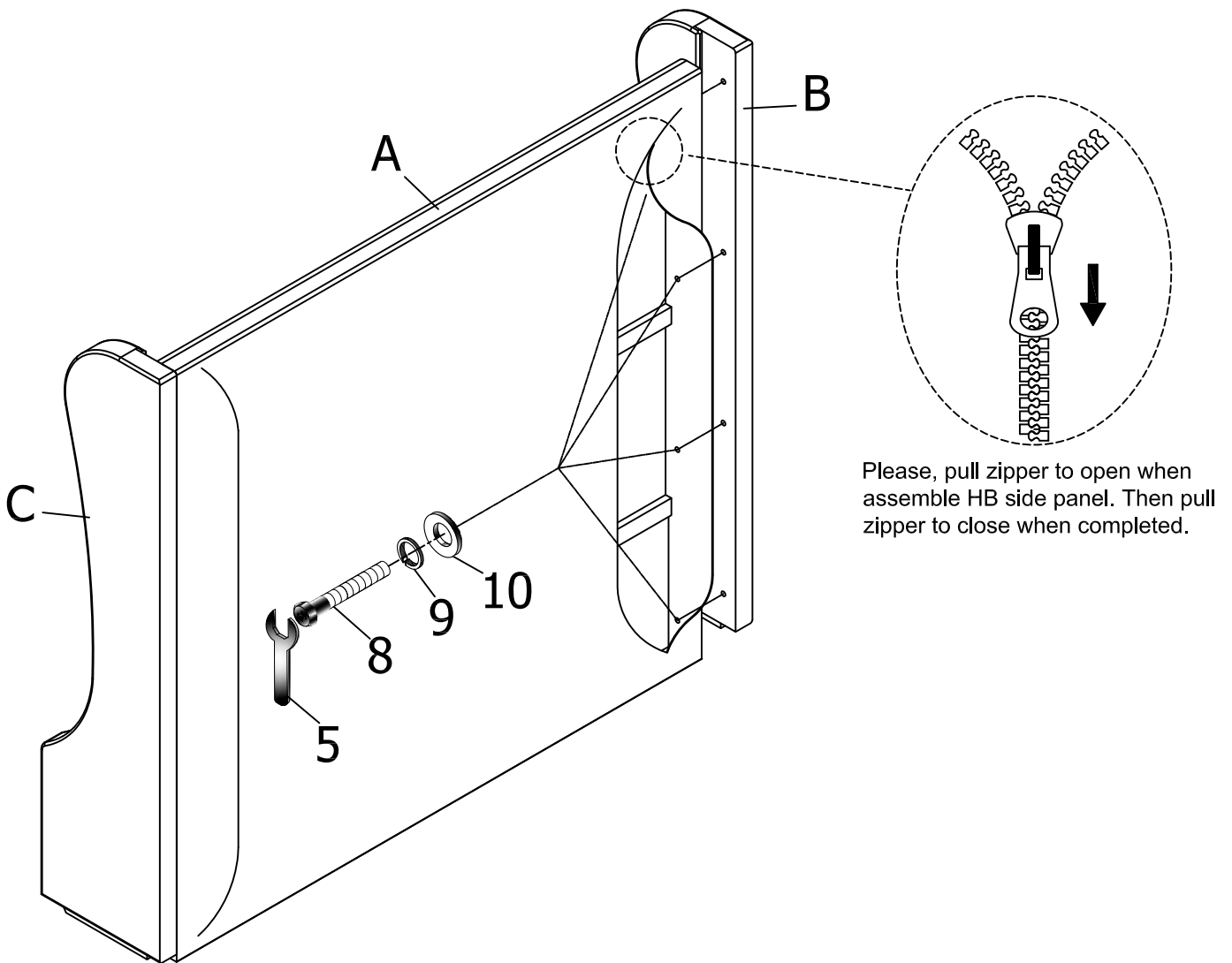

STEP 2

INSTRUCTION SHEET







ASSEMBLY INSTRUCTIONS

U011220/ U01122FR/ U011SLKG UPH Bed King 66





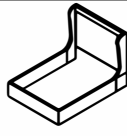

OPTION 1: MATTRESS WITH FOUNDATION

Assembly Procedure: (Please follow the sketches below.)

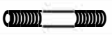
Parts List:

Description		QTY	Description		QTY
Side Rail (D)		2 pcs	Support Leg (G)		5 pcs
			Slat (H)		5 pcs
Support bar (E)		2 pcs	Bed Cover (L)		1 set
Footboard (F)		1 pc			

Side Rail Hardware List:

1	Threaded bolt	5/16"x3"		8 pcs	5	Wrench	12mm		1 pc
2	Curve washer	5/16"		8 pcs	6	Screw	#8x1-1/4"		10 pcs
3	Spring washer	5/16"		8 pcs	7	Wood dowel	ø10x40mm		4 pcs
4	Nut	5/16"		8 pcs					

Step 3: Assemble siderail (C) to headboard (A) and footboard (B) using Threaded bolt (1), curve washer (2), spring washer (3), nut (4). Tighten all nuts securely with Wrench (5), but do not over tighten.

Step 4: Assemble Support bar (E) to HB left side (B) and HB right side (C) using Hex Head bolt (8), spring washer (9), flat washer (10). Tighten all bolts securely with Wrench (5), but do not over tighten the bolts.

Step 5: Assemble each support leg (D) into each slat (E).

Step 6: Attach each slat (E) on the side rails (C) using screws (6) as shown. Adjust the height of each support leg (D) by turning adjustable levelers located on the bottom of each support leg (D), clockwise to lower and counterclockwise to raise.

Step 7: Assemble bed cover (L) to Bed.

Assembly is now complete.

INSTRUCTION SHEET

ASSEMBLY INSTRUCTIONS

U011220/ U01122FR/ U011SLKG UPH Bed King 66

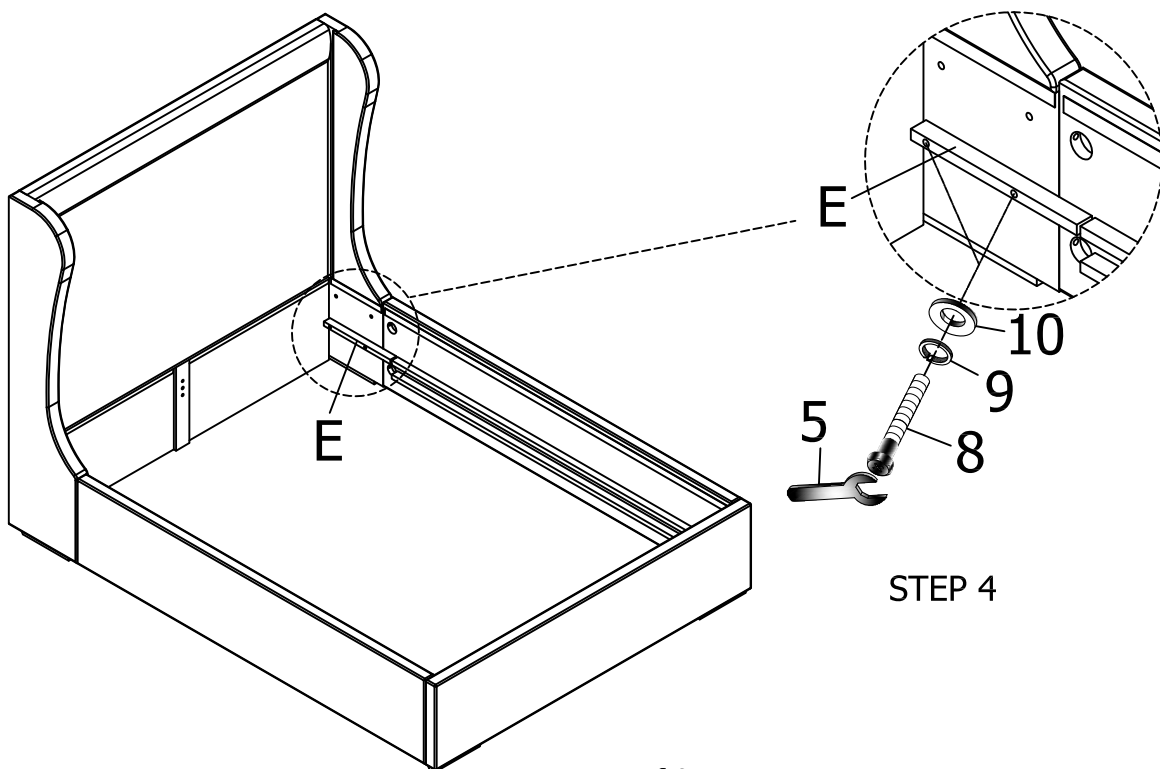
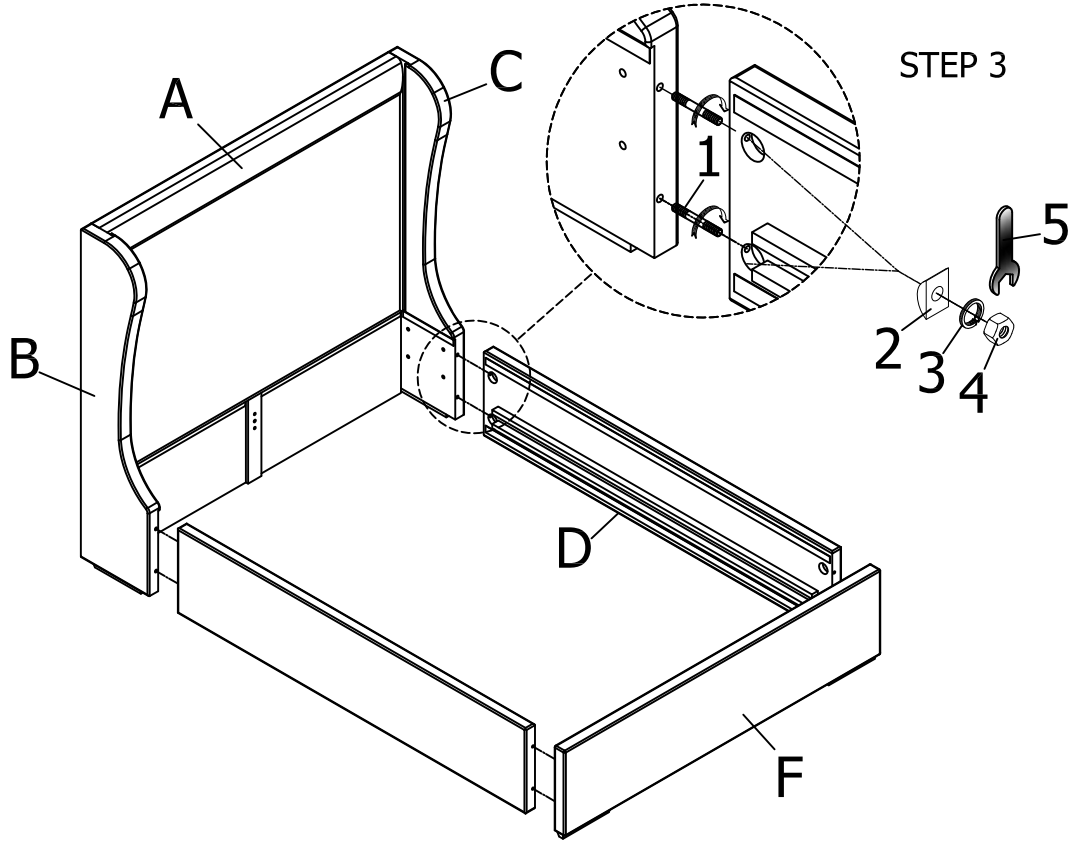

INSTRUCTION SHEET

ASSEMBLY INSTRUCTIONS

U011220/ U01122FR/ U011SLKG UPH Bed King 66

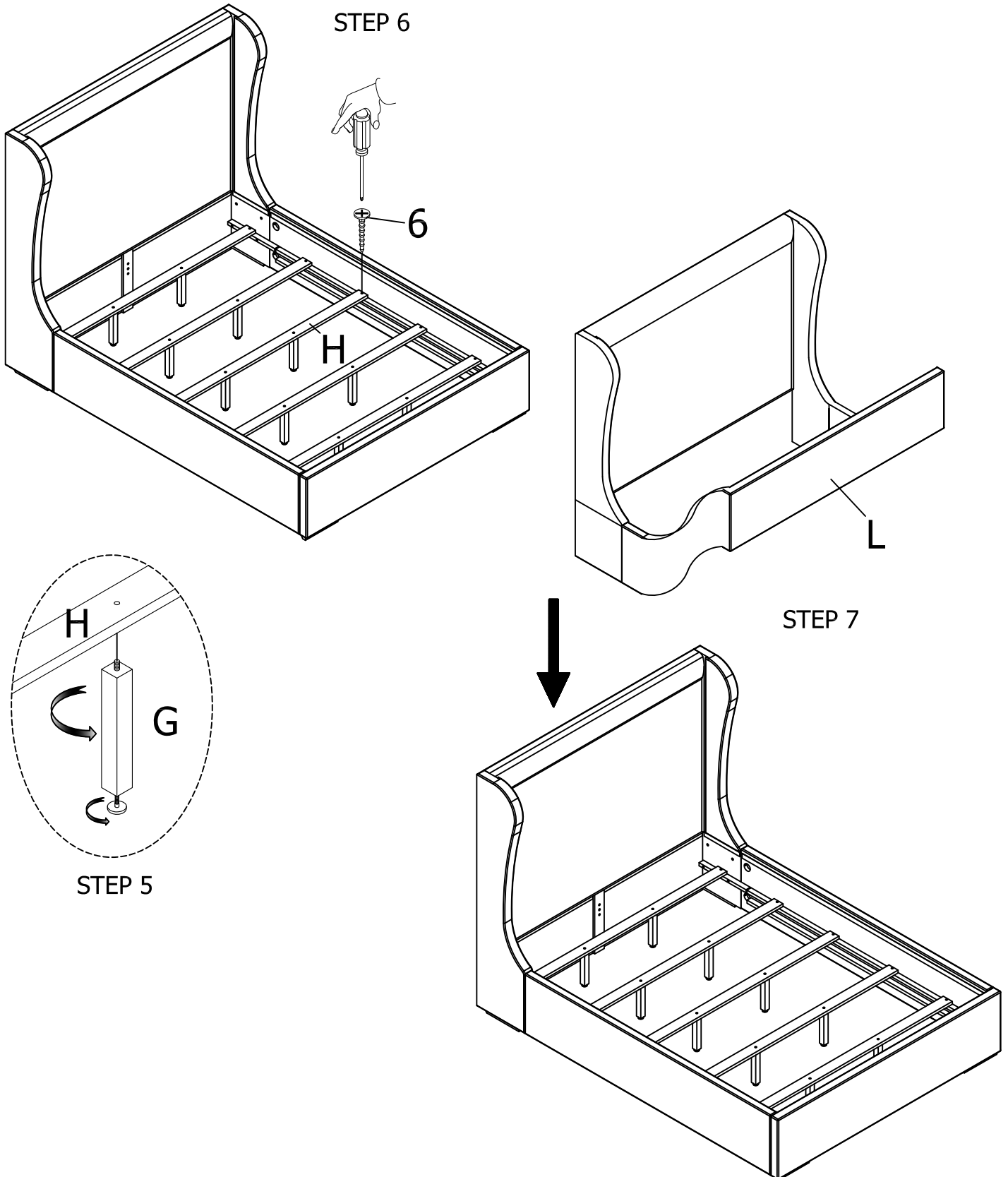







INSTRUCTION SHEET

ASSEMBLY INSTRUCTIONS





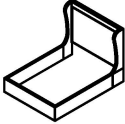

U011220/ U01122FR/ U011SLKG UPH Bed King 66

OPTION 2: MATTRESS ONLY - NOTE: CENTER RAIL SLAT ROLL AND HARDWARE SOLD SEPERATELY

Parts List:

Description		QTY	Description		QTY
Side Rail (D)		2 pcs	Center rail support (J)		1 pc
			Slat roll (K)		1 set
Support bar (E)		2 pcs	Bed Cover (L)		1 set
Footboard (F)		1 pc			
Center Rail (I)		1 pc			

Side Rail Hardware List:

1	Threaded bolt	5/16"x3"		10 pcs	5	Wrench	12mm		1 pc
2	Curve washer	5/16"		10 pcs	6	Screw	#8x1-1/4"		15 pcs
3	Spring washer	5/16"		10 pcs	7	Wood dowel	φ10x40mm		4 pcs
4	Nut	5/16"		10 pcs					

Step 3: Assemble Center rail support (G) into Center rail (F).

Step 4: Assemble siderail (C) to headboard (A) using Threaded bolt (1), curve washer (2), spring washer (3), nut (4). Tighten all nuts securely with Wrench (5), but do not over tighten.

Insert the dowel (7) into the Headboard (A) as shown. Assemble Center rail (G) to headboard (A) using Threaded bolt (1), curve washer (2), spring washer (3), nut (4). Tighten all nuts securely with Wrench (5), but do not over tighten.

Step 5: Assemble Support bar (E) to HB left side (B) and HB right side (C) using using Hex Head bolt (8), spring washer (9), flat washer (10). Tighten all bolts securely with Wrench (5), but do not over tighten the bolts.

Step 6: Insert the dowel (7) into the Footboard (B) as shown. Assemble the footboard (B) to the Center rail (G) and the side rail (C) using Threaded bolt (1), curve washer (2), spring washer (3), nut (4). Tighten all nuts securely with Wrench (5), but do not over tighten.

Step 7: Attach the slat roll (H) on the side rails (C) using screws (6) as shown. Adjust the height of center rail support (G) by turning adjustable levelers located on the bottom of center rail support (G), clockwise to lower and counterclockwise to raise.

Step 8: Assemble bed cover (L) to Bed.

Assembly is now complete.

INSTRUCTION SHEET

ASSEMBLY INSTRUCTIONS

U011220/ U01122FR/ U011SLKG UPH Bed King 66

OPTION 2: MATTRESS ONLY

Assembly Procedure: (Please follow the sketches below.)

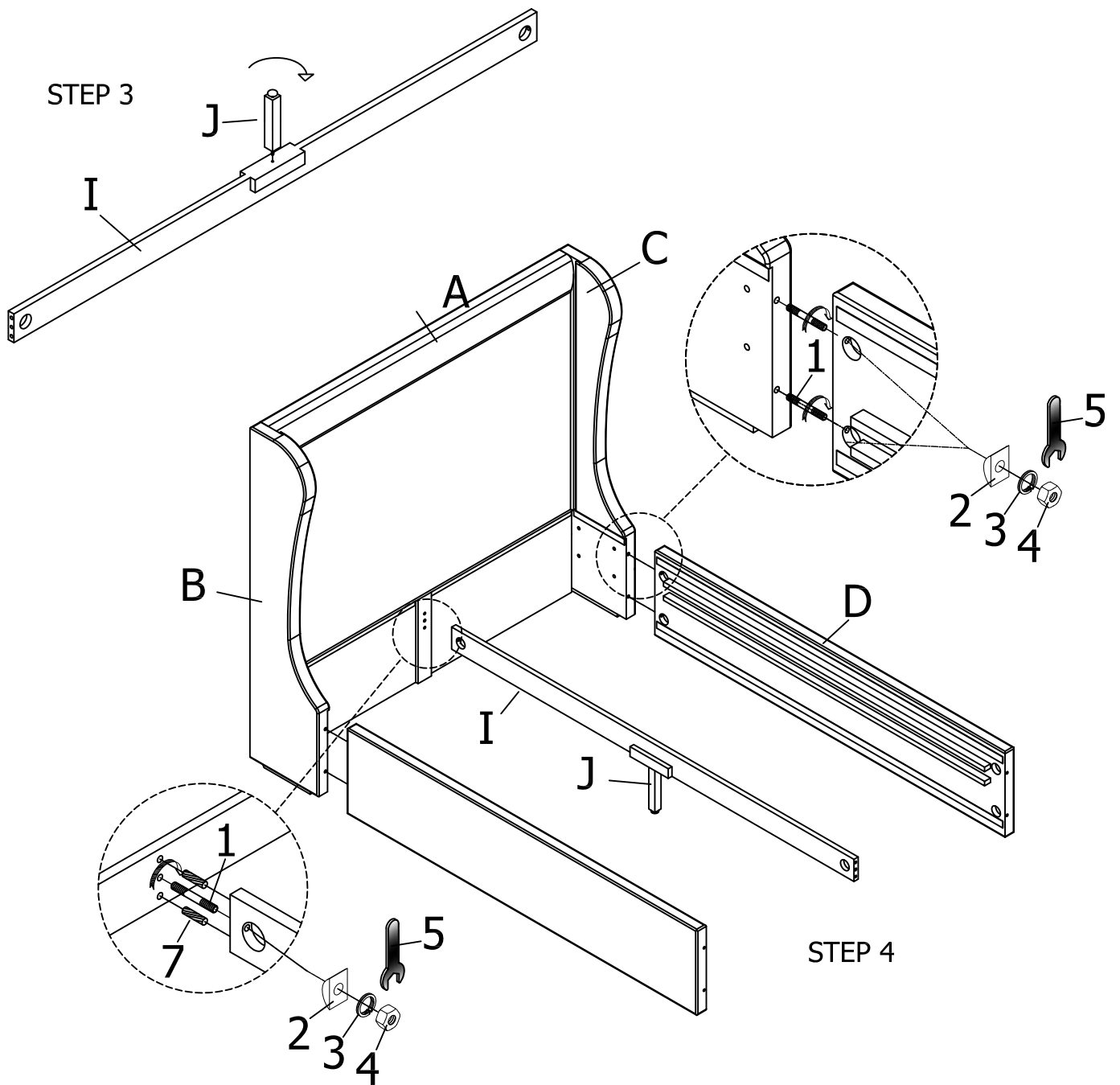

INSTRUCTION SHEET

ASSEMBLY INSTRUCTIONS

U011220/ U01122FR/ U011SLKG UPH Bed King 66

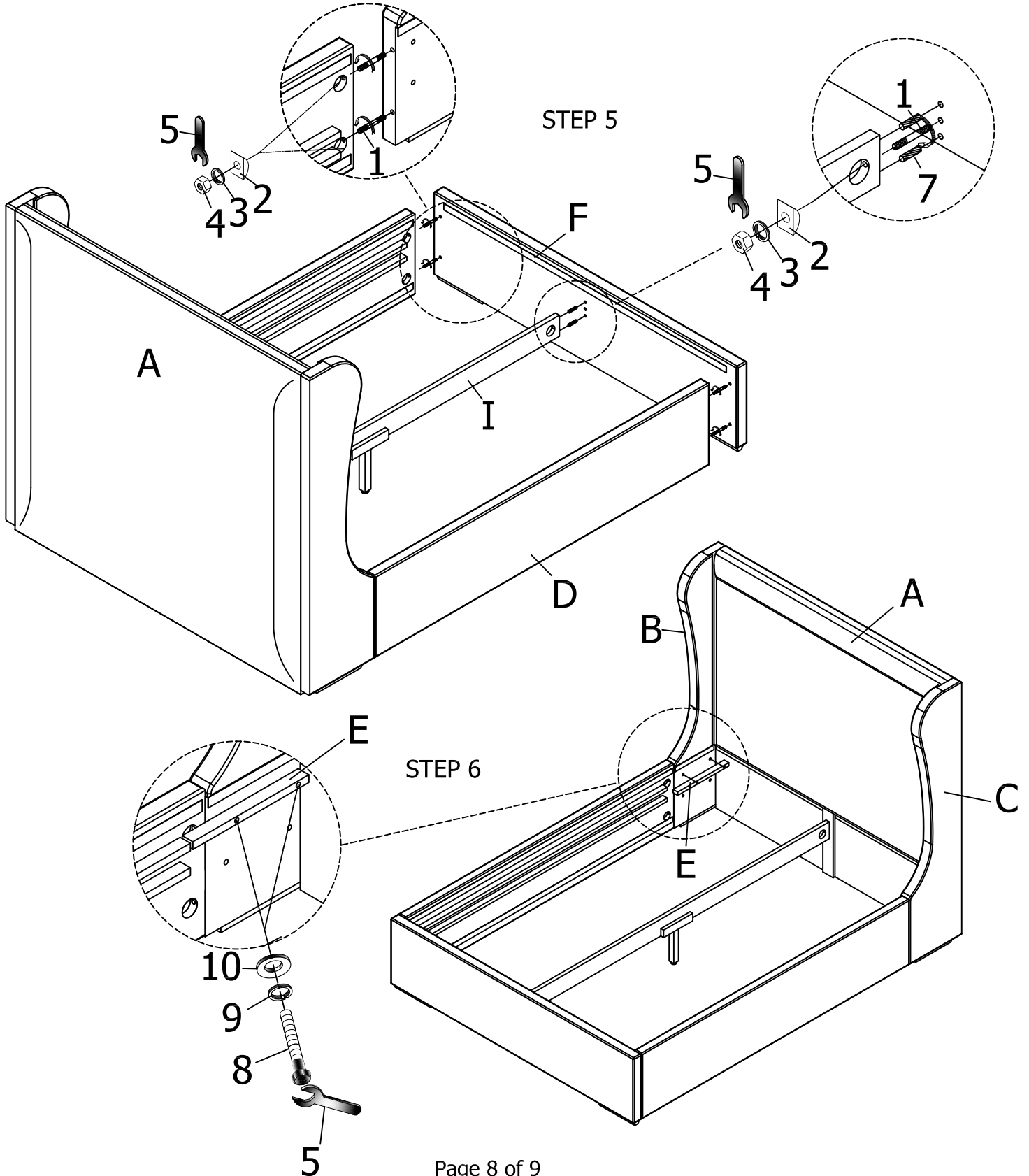

INSTRUCTION SHEET

ASSEMBLY INSTRUCTIONS

U011220/ U01122FR/ U011SLKG UPH Bed King 66

