













**Parts List & Hardware List**

PART LIST			QTY	PART LIST			QTY
A	HEADBOARD		1FC	D	RIGHT RAIL		1FC
B	FOOTBOARD		1FC	E	SLAT		3PCS
C	LEFT RAIL		1FC	F	SUPPORT LEG		3PCS
				G	MATTRESS SUPPORT PANEL		4PCS

HARDWARE LIST			QTY	HARDWARE LIST			QTY
1	NUT	 5/16"	8PCS	4	BOLT	 5/16"x3"	8PCS
2	SPRING WASHER	 5/16"	8PCS	5	WRENCH	 70*30*5mm	1FC
3	CURVED WASHER	 5/16"L32*13*8mm	8PCS	6	WOODSCREW	 #8*1"	14PCS

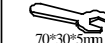

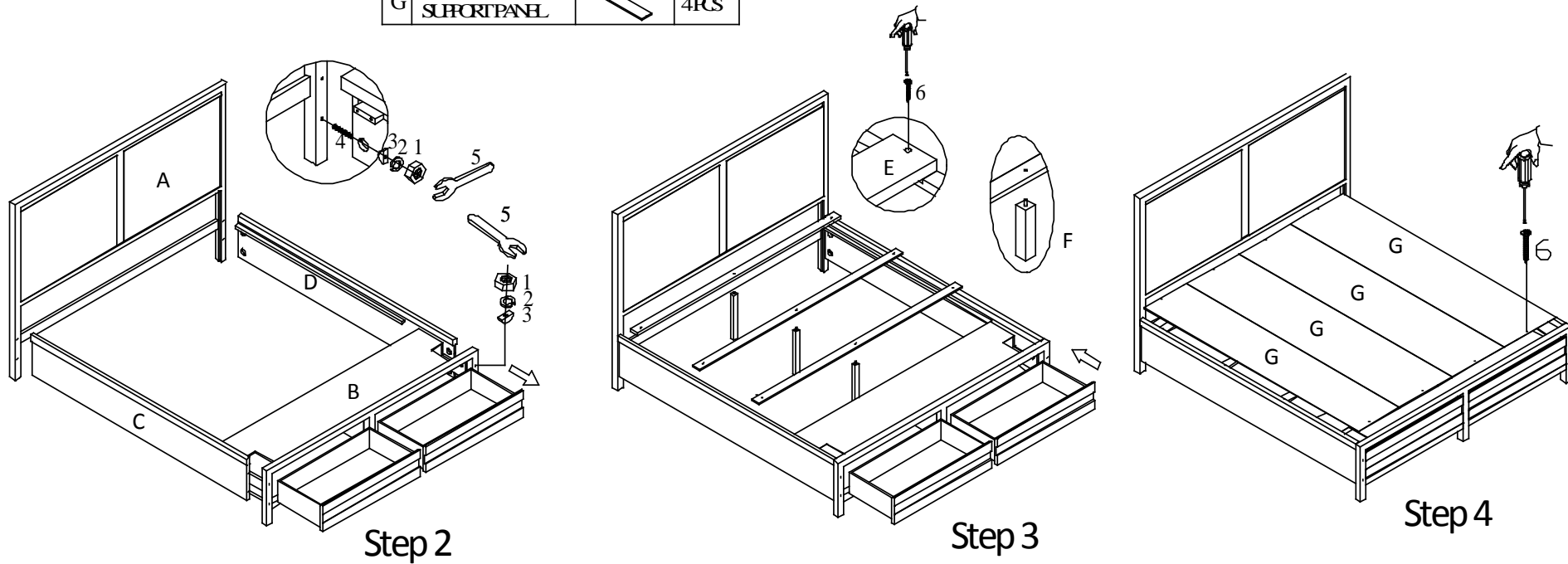
**Assembly Procedures:**

Step 1: Lay out all parts and hardware. Make sure the quantity of each is correct.

Step 2: Remove the drawers from the footboard. Assemble the right rail and left rail to headboard and footboard.

Step 3: Screw the center leg supports to slats. Assemble the slats to side rails. **Make sure the slats are evenly spaced with the front slat assembled flush against the headboard.**

Step 4: Assemble the mattress support panels to slats and footboard. Install the drawers in the footboard.

**Assembly is now complete.**