

## INSTRUCTION SHEET

543A230/23F/23R  
543A240/24F/24R

Sojourn Bed 5/0 6/6

Thank you for purchasing this quality product. Be sure to check all packing material carefully for small parts that may have come loose inside the carton during shipment.

**Caution:** (1) These parts are cumbersome and heavy. This product can best be assembled with the assistance of one or more persons in order to prevent personal injury and to insure parts are not damaged during the assembly process. If dirty, clean finished parts with mild dishwashing liquid and water solution applied on damp cloth. Cloth should not be excessively wet. Polish finish with soft cloth and an industry recognized furniture polish.

(2) To prevent damage to your floor or carpet, please check the bottom of each piece of furniture for stain residue and rough surfaces and also check for staples or nails left after removing the packaging material. The manufacturer will not be held responsible if preventative steps are not taken prior to installation.

(3) Unpack and dispose of all packing material but be careful not to throw away any assembly parts or hardware. Read the instruction sheet and parts list carefully. Remove all staples and screws used for packaging carefully using pliers and or screwdrivers to prevent injury and scratching or damaging flooring.

(4) During normal use everyday, screws, bolts, nuts and wooden plugs may loosen up. They should be periodically inspected and re-tightened to prevent damage to the furniture and (or) personal property or cause injury. Always check to be sure all hardware on this list and the above mentioned components is attached to the furniture properly and kept tightened at all times.

### PARTS LIST:

#	Description	Qty.	#	Description	Qty.
A	Headboard	1pc	B	Footboard	1pc
C	Cleat	2pcs	D	Feet	4pcs
E	Side Rail	2pcs	F	slat	3pcs
G	Support leg	3pcs	H	Hardware pack	1bag

**Assembly Procedure:** (Please follow the sketches below.)







**Step 1:** Unpack, inspect, and read assembly instruction carefully. Lay out the parts and hardware. Make sure the quantity of each is correct.

**Step 2:** Put the headboard (A) and footboard (B) upright down on a soft and smooth surface to avoid damage or being scratched. Then attach the bed feet (D) and cleats (C) to headboard (A). And attach the bed feet (D) to footboard (B) also.

**Step 3:** Attach the side rails (E) to the headboard (A) and footboard (B) with nut (1), spring washer (2), curved washer (4) and bolts (3) using wrench (5). And attach the support leg (G) to the Slat (F) by hand. Then screw the slats (F) to the side rails (E) using screwdriver (not provided).

**Note:** 543A/C-240/24R/24F has 6 pieces support legs.

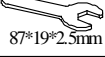
**Assembly is now complete.**

HARDWARE LIST(H)			QTY
1	NUT	 5/16"	8 PCS
2	SPRING WASHER	 5/16"	8 PCS
3	BOLT	 5/16"x4"	8 PCS
4	CURVED WASHER	 5/16"L32*13*8mm	8 PCS
5	WRENCH	 87*19*2.5mm	1 PC
6	WOOD SCREW		6 PCS

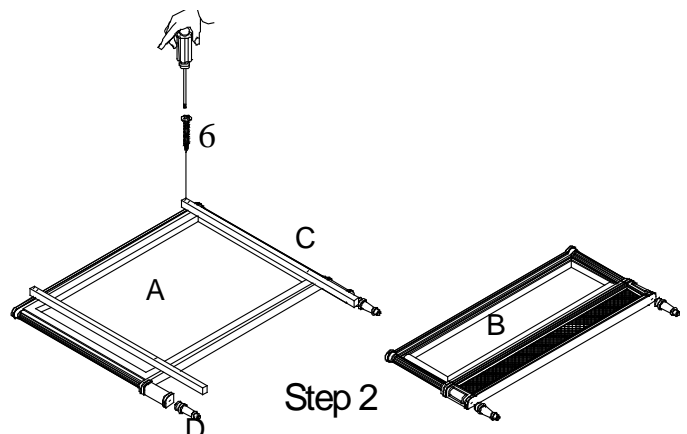

## INSTRUCTION SHEET

543A230/23F/23R  
543A240/24F/24R

Sojourn Bed 5/0 6/6

