

INSTRUCTION SHEET

987356 / 988356

Night Table

Thank you for purchasing this quality product. Be sure to check all packing material carefully for small parts that may have come loose inside the carton during shipment.

Caution: (1) These parts are cumbersome and heavy. This product can best be assembled with the assistance of one or more persons in order to prevent personal injury and to insure parts are not damaged during the assembly process. If dirty, clean finished parts with mild dishwashing liquid and water solution applied on damp cloth. Cloth should not be excessively wet. Polish finish with soft cloth and an industry recognized furniture polish.

(2) To prevent damage to your floor or carpet, please check the bottom of each piece of furniture for stain residue and rough surfaces and also check for staples or nails left after removing the packaging material. The manufacturer will not be held responsible if preventative steps are not taken prior to installation.

(3) Unpack and dispose of all packing material but be careful not to throw away any assembly parts or hardware. Read the instruction sheet and parts list carefully. Remove all staples and screws used for packaging carefully using pliers and or screwdrivers to prevent injury and scratching or damaging flooring.

(4) During normal use everyday, screws, bolts, nuts and wooden plugs may loosen up. They should be periodically inspected and re-tightened to prevent damage to the furniture and (or) personal property or cause injury. Always check to be sure all hardware on this list and the above mentioned components is attached to the furniture properly and kept tightened at all times.

PARTS LIST:

#	Description	Qty.	#	Description	Qty.
A	Table Top	1 pc	B	Post	4 pcs
C	Shelf	1 pc	D	Hardware Pack	1 bag

Assembly Procedure: (Please follow the sketches below.)

Step 1: Unpack, inspect, and read assembly instruction carefully. Lay out the parts and hardware. Make sure the quantity of each is correct.

Step 2: Take off the drawer from table top (A). Put the table top (A) upright down on a soft and smooth surface to avoid damage or being scratched. Attach three posts (B) to the table top (A) with phillip head bolt (1), spring washer (2), flat washer (3) by using wrench (4). Make sure all bolts were tightened.

Step 3: Attach the shelf (C) to three posts (B) with phillip head bolt (5), spring washer (6), flat washer (7) and angle brackets (8) by using wrench (4). Then attach the rest post (B) to the table top (A) phillip head bolt (1), spring washer (2), and flat washer (3) by using wrench (4). At last, attach the shelf (C) to the rest post (B) with phillip head bolt (5), spring washer (6), flat washer (7) and bracket (8) by using wrench (4). When you're attaching the shelf (C) to the posts (B), you'd better tighten the bolt to attach the posts (B) first and then tighten the bolt to attach the shelf (C).

Step 4: Turn the table upright. Put the drawer in place.

Assembly is now complete.





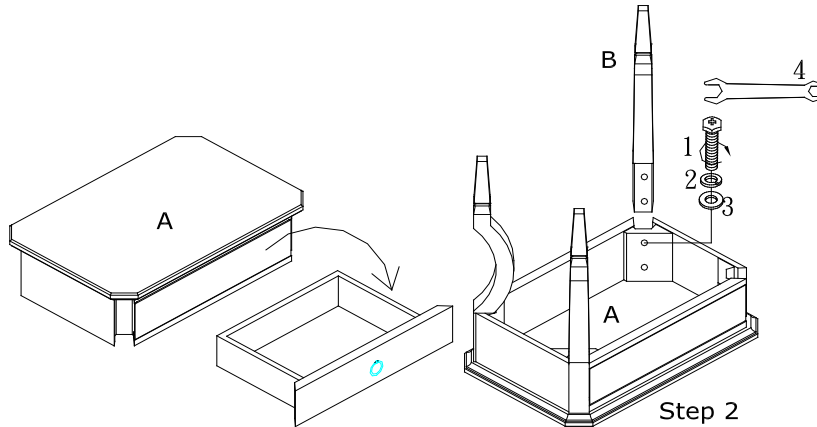

INSTRUCTION SHEET

987356 / 988356

Night Table

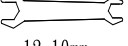

Hardware pack (D)

1	Phillip head bolt	 5/16" * 2-1/4"	8PCS
2	Flat washer	 5/16"	8PCS
3	Flat washer	 5/16" * 23*2mm	8PCS
4	Wrench	 12-10mm	1PC
5	Phillip head bolt	 1/4" * 5/8"	8PCS
6	Spring washer	 1/4"	8PCS
7	Flat washer	 1/4" * 13*1.5mm	8PCS
8	Bracket	 32*18*17.5*2mm	4PCS

