

Thank you for purchasing this quality product. Be sure to check all packing material carefully for small parts that may have come loose inside the carton during shipment.

**Caution:** (1) These parts are cumbersome and heavy. This product can best be assembled with the assistance of one or more persons in order to prevent personal injury and to insure parts are not damaged during the assembly process. If dirty, clean finished parts with mild dishwashing liquid and water solution applied on damp cloth. Cloth should not be excessively wet. Polish finish with soft cloth and an industry recognized furniture polish.

(2) To prevent damage to your floor or carpet, please check the bottom of each piece of furniture for stain residue and rough surfaces and also check for staples or nails left after removing the packaging material. The manufacturer will not be held responsible if preventative steps are not taken prior to installation.

(3) Unpack and dispose of all packing material but be careful not to throw away any assembly parts or hardware. Read the instruction sheet and parts list carefully. Remove all staples and screws used for packaging carefully using pliers and or screwdrivers to prevent injury and scratching or damaging flooring.

**Note:** The bed should not be moved after it has been assembled without first disassembling the bedrails. Excessive movement while the bedrails are locked into place may cause damage to the bed's parts or even cause personal injury.

### **Assembly Procedures:**

Step 1: Lock the bed side rails by bolts into the posts of the headboard and the footboard as explained and shown in the sketch on the assembly instruction sheet provided. Be sure to follow the steps carefully as described in these assembly instructions when first putting the bed together to avoid personal injury or damage to the bed and its components.

Step 2: It is extremely important that you use a slat support system for your box spring and mattress or a free standing Metal bed frame. The bed is not designed to simply hold up the box spring and mattress by only using the cleats attached to the side rails. This slat support system may not always come with the wooden bed. It may have to be bought separately and should be provided by the furniture retailer who sold you the bed. Failure to use a slat support system with support feet could cause personal injury or damage to your box spring and mattress.

Step 3: Be sure to always use a slat support system which uses support feet. Always attach these support feet as instructed and be sure they are attached properly and extend fully between the floor and the slat. There should be no space between the floor and the bottom of the slat and or box spring that is not fully supported. The slat system can either be made of wood or metal and should be using the same principles described here.

Step 4: Extend and place the slats onto the top of the cleats already attached to the bed's side rails. (see sketch). Take care to space the (3) slats evenly apart between the head board and foot boards. Do not simply place the slats near the head board and the foot board leaving no support in the center. After you have measured the placement of the slats be sure to follow the directions to screw down the slats onto the bed's cleats. (These cleats are already attached to the bed's side rails.)

Step 5: After completing all the steps above you can insert the box spring(s) and mattress.

**For All beds:**

Step 1: Lay out all the parts and hardware. Make sure the quantity of each it correct.

Step 2: Insert bolts (1) into the headboard, and then attach the rails to the headboard and footboard with nuts (5), spring washers (2) and brackets (3) and use the wrench (4) to tighten them.

Step 4: Attach center support legs onto slats





Step 5: Screw slats onto side rails with screwdriver (not provided). There are three slats, please distribute each space evenly.

Step 6: Adjust height of center support legs with screw adjustment.

**Note: When you are assembling California King Bed, refer to the steps of King Bed. Queen bed have three center supports and King bed have six center supports.**

**Assembly is now complete.**

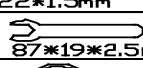
**HARDWARE PACK**

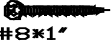
|   |               |  |      |
|---|---------------|--|------|
| 1 | BOLT          |  5/16"×4"     | 8PCS |
| 2 | SPRING WASHER |  5/16"×13×2mm | 6PCS |
| 3 | BRACKET       |  22×1.5mm     | 1PCS |
| 4 | WRENCH        |  87×19×2.5mm  | 8PCS |
| 5 | NUT           |  5/16"       | 8PCS |
| 6 | WOOD SCREW    |  #8×1"      | 8PCS |

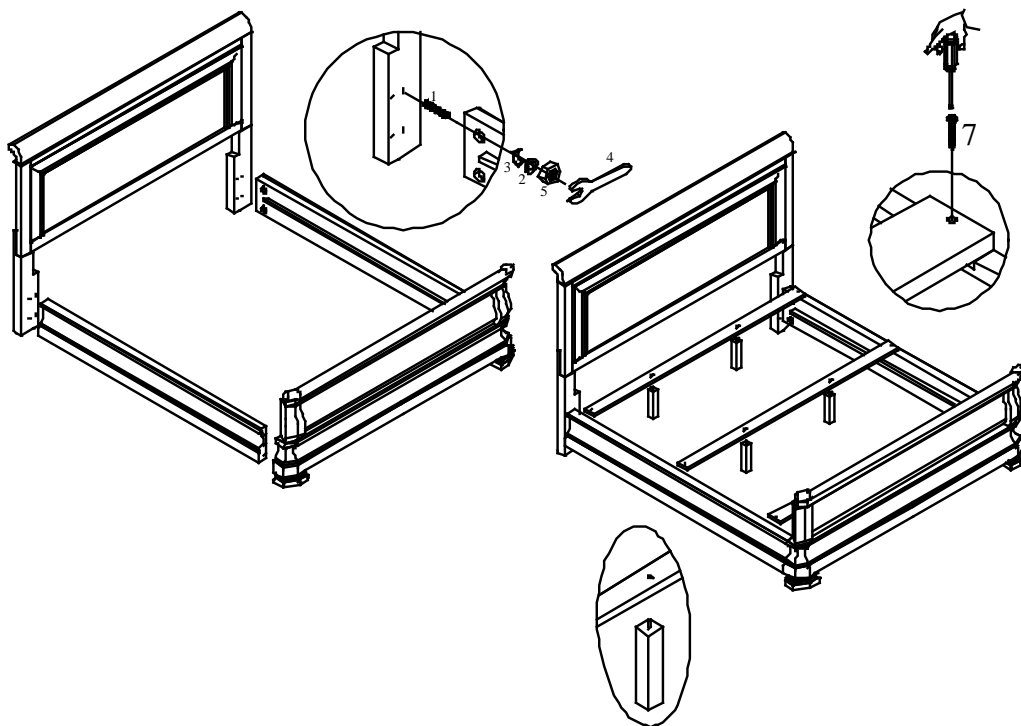

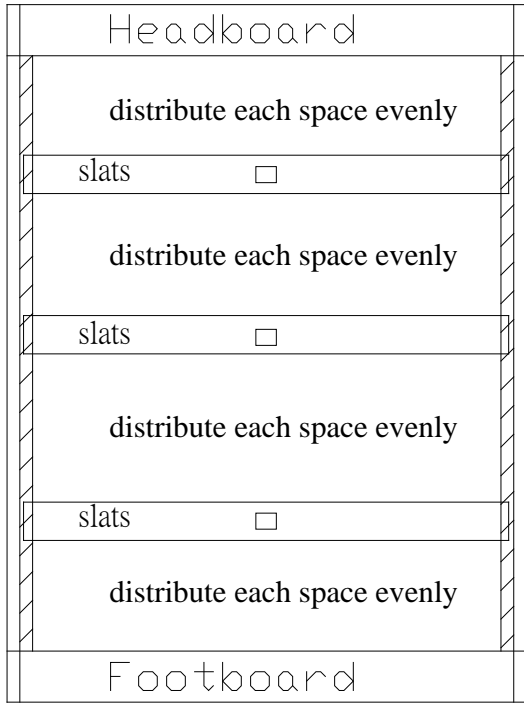

For Queen Bed

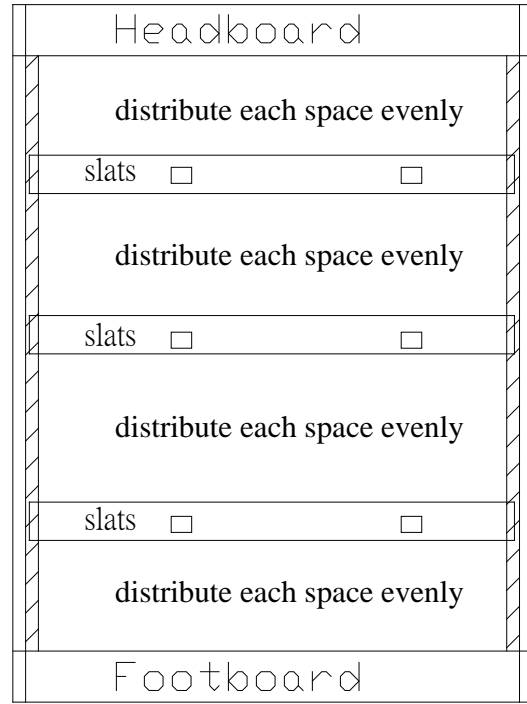

For King Bed