

FOR ALL BEDS ASSEMBLY PROCEDURES:

- Step 1: Lay out all parts and hardware. Make sure the quantity of each is correct. Please refer to hardware list.
- Step 2: Insert the threaded housing (A) into the pre-bored hole at both ends of side rails.
- Step 3: Insert wooden dowel (B) into the pre-bored hole located at the bottom side of each headboard & footboard frame.
- Step 4: Screw threaded connecting bolt (C) into the pre-bored hole at ends of both headboard & footboard.
- Step 5: Attach the side rails to the headboard and tighten threaded housing using Allen wrench (D). Repeat the same steps for footboard & side rail assembly.

SLATS:

The Slat system supports the box spring and mattress of your Bed.

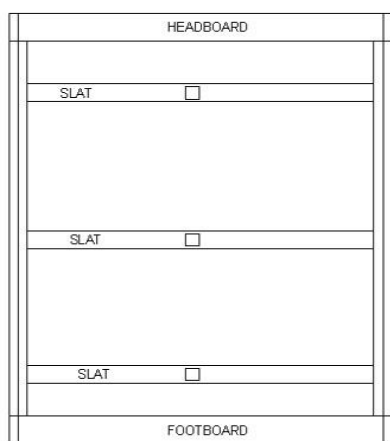

1. Attach one slat support foot in the center for Queen Bed/ two slat supports for King.
2. Place slats in side rail cleats notches. Insert one steel slat pin in each hole to hold the slat in place. The pins are designed to allow a small amount of play in the unit.
3. Adjust the levelers on each slat support until it touches the floor.



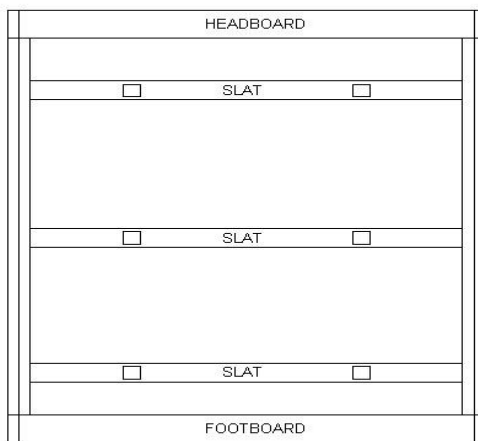

FOR QUEEN BED



FOR KING BED

HARDWARE LIST			
	DESIGN	DESCRIPTION	QTY
A		THREADED HOUSING	8
B		WOODEN DOWEL	8

HARDWARE LIST			
	DESIGN	DESCRIPTION	QTY
C		THREADED CONNECTING BOLT	8
D		ALLEN WRENCH	1
E		STEEL PIN	6

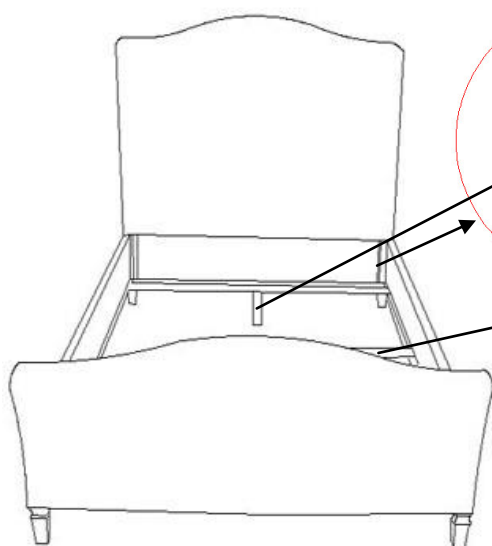
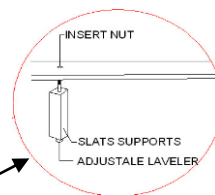

QUEEN HEADBOARD

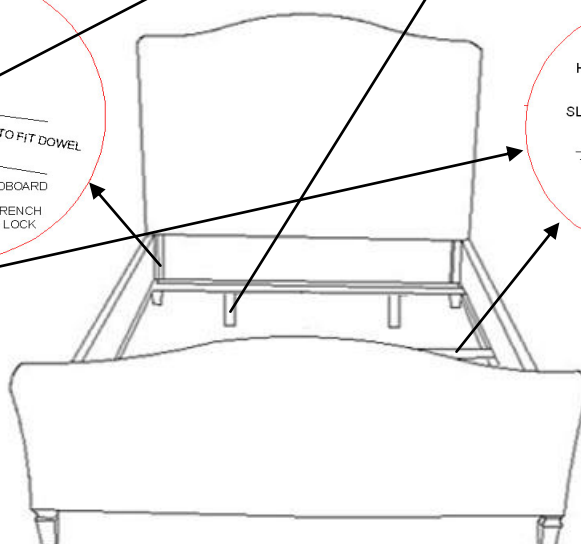

KING HEADBOARD

